

EasyClip⁺

Sistema Autoligado Dual Control
Pasivo / Interactivo

ADITEK
Innovando sonrisas

Clip de NITINOL
no removible.

● Más de 250.000
casos instalados
por el
mundo.

● Satisfacción de
nuestros clientes.

● Diferentes tesis presentadas
basadas en su uso.



● El sistema de autoligado
más completo del mercado.

● Pionero en el
mercado brasileiro.

● Único
bracket autoligado
en Brasil
con patente en EE.UU.



Orthodont

CASA CENTRAL:

Junín 987 1º piso, C.A.B.A.
Tel./Fax: (+54) (011) 4961-9260
info@orthodont.com.ar

 +54 9 11 6959-8903

www.orthodont.com.ar

 /orthodont.argentina

 @OrthodontOK

 Orthodont Argentina

 @orthodont_argentina

EasyClip⁺

Sistema Autoligado Dual Control

Pasivo / Interactivo



Orthodont

- ① Guía en forma de "V" para facilitar la posición

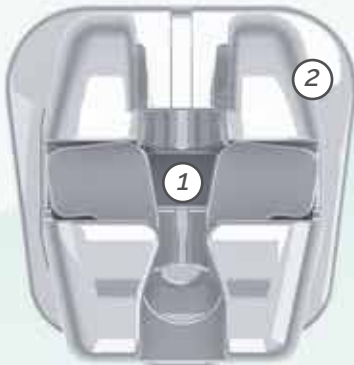

PASIVO

- ② Gemelos de brackets redondeadas



INTERACTIVO



CLIP CON TAPA RECTA



CLIP CON TAPA CURVA

CLIP DE NITINOL
NO REMOVIBLE

ADITEK[®]
Innovando sonrisas



PASIVO
.014" / .016" / .018"



PRIMER ARCO INTERACTIVO
.016" x .022"



ACTIVO
.019" x .025"



EasyClip⁺

Cobertura M-D por el clip.
Total control rotacional



- El autoligado con más bajo perfil.
- Bracket sinterizado con tecnología MIM.
- Mayor resistencia adhesiva.



Totamente Pasivo

PASIVO

Prescripciones disponibles:

- DAMON LOW TORQUE (.022")
- DAMON STANDARD (.022")
- DAMON HIGH TORQUE (.022")
- ROTH (.018" y .022")
- MBT (.018" y .022")



Totamente Activo

ACTIVO

Un sistema.

Múltiples aplicaciones.

Facilidad en el manejo clínico.

Calidad de vida.

- Customización del grado de interacción.
- Sistema de fuerzas individualizadas.
- Integración total.



Interactivo .018" / .022"

Pasivo .018" / .022"

HÍBRIDO

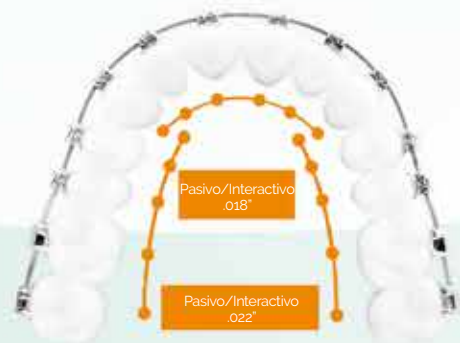

Pasivo/Interactivo .018"

Pasivo/Interactivo .022"

PASIVO/INTERACTIVO
BIDIMENSIONAL

Prescripciones disponibles:

- ROTH
- MBT

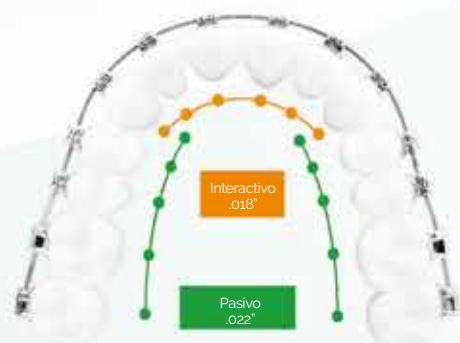

Interactivo .018"

Pasivo .022"

HÍBRIDO BIDIMENSIONAL



/orthodent.argentina



@OrthodentOK



Orthodent Argentina



@orthodent_argentina

Prescripción DAMON* STANDARD

SLOT .022" x .028"

Kit c/hook 3, 4, 5: 20 piezas

Longitud M-D	3 mm	3 mm	3 mm	2,7 mm	2,9 mm	2,9 mm	2,7 mm	3 mm	3 mm	3 mm
Torque:	-11°	-11°	7°	6°	15°	15°	6°	7°	-11°	-11°
Tip:	2°	2°	5°	9°	5°	5°	9°	5°	2°	2°
Rotación:	2°	2°	4°	0°	0°	0°	0°	4°	2°	2°
In-Out:	0,25mm	0,25mm	0,25mm	0,65mm	0,50mm	0,50mm	0,65mm	0,25mm	0,25mm	0,25mm
	15	14	13	12	11	21	22	23	24	25
Maxilar										
Mandibular										
	45	44	43	42	41	31	32	33	34	35
Longitud M-D	3 mm	3 mm	2,9 mm	2,7 mm	2,7 mm	2,7 mm	2,7 mm	2,9 mm	3 mm	3 mm
Torque:	-17°	-12°	7°	-3°	-3°	-3°	-3°	7°	-12°	-17°
Tip:	4°	4°	5°	4°	2°	2°	4°	5°	4°	4°
Rotación:	4°	4°	4°	0°	0°	0°	0°	2°	4°	4°
In-Out:	0,15mm	0,15mm	0,20mm	0,45mm	0,45mm	0,45mm	0,45mm	0,20mm	0,15mm	0,15mm

Prescripción DAMON* LOW TORQUE

SLOT .022" x .028"

Kit c/hook 3, 4, 5: 20 piezas

Longitud M-D	3 mm	3 mm	3 mm	2,7 mm	2,9 mm	2,9 mm	2,7 mm	3 mm	3 mm	3 mm
Torque:	-11°	-11°	-9°	-5°	2°	2°	-5°	-9°	-11°	-11°
Tip:	2°	2°	5°	9°	5°	5°	9°	5°	2°	2°
Rotación:	2°	2°	4°	0°	0°	0°	0°	4°	2°	2°
In-Out:	0,25mm	0,25mm	0,25mm	0,65mm	0,50mm	0,50mm	0,65mm	0,25mm	0,25mm	0,25mm
	15	14	13	12	11	21	22	23	24	25
Maxilar										
Mandibular										
	45	44	43	42	41	31	32	33	34	35
Longitud M-D	3 mm	3 mm	2,9 mm	2,7 mm	2,7 mm	2,7 mm	2,7 mm	2,9 mm	3 mm	3 mm
Torque:	-17°	-12°	0°	-11°	-11°	-11°	-11°	0°	-12°	-17°
Tip:	4°	4°	5°	4°	2°	2°	4°	5°	4°	4°
Rotación:	4°	4°	2°	0°	0°	0°	0°	2°	4°	4°
In-Out:	0,15mm	0,15mm	0,20mm	0,45mm	0,45mm	0,45mm	0,45mm	0,20mm	0,15mm	0,15mm

Prescripción DAMON* HIGH TORQUE

SLOT .022" x .028"

Kit c/hook 3, 4, 5: 20 piezas

Longitud M-D	3 mm	3 mm	3 mm	2,7 mm	2,9 mm	2,9 mm	2,7 mm	3 mm	3 mm	3 mm
Torque:	-11°	-11°	11°	13°	22°	22°	13°	11°	-11°	-11°
Tip:	2°	2°	5°	9°	5°	5°	9°	5°	2°	2°
Rotación:	2°	2°	4°	0°	0°	0°	0°	4°	2°	2°
In-Out:	0,25mm	0,25mm	0,25mm	0,65mm	0,50mm	0,50mm	0,65mm	0,25mm	0,25mm	0,25mm
	15	14	13	12	11	21	22	23	24	25
Maxilar										
Mandibular										
	45	44	43	42	41	31	32	33	34	35
Longitud M-D	3 mm	3 mm	2,9 mm	2,7 mm	2,7 mm	2,7 mm	2,7 mm	2,9 mm	3 mm	3 mm
Torque:	-17°	-5°	13°	-3°	-3°	-3°	-3°	13°	-5°	-17°
Tip:	4°	4°	5°	4°	2°	2°	4°	5°	4°	4°
Rotación:	4°	4°	2°	0°	0°	0°	0°	2°	4°	4°
In-Out:	0,15mm	0,15mm	0,20mm	0,45mm	0,45mm	0,45mm	0,45mm	0,20mm	0,15mm	0,15mm

Prescripción ROTH

SLOT .018" x .028" / .022" x .028"

Kit c/hook 3, 4, 5: 20 piezas

Longitud M-D	3 mm	3 mm	3 mm	2,7 mm	2,9 mm	2,9 mm	2,7 mm	3 mm	3 mm	3 mm
Torque:	-7°	-7°	0°	8°	12°	12°	8°	0°	-7°	-7°
Tip:	0°	0°	11°	9°	5°	5°	9°	11°	0°	0°
Rotación:	2°	2°	4°	0°	0°	0°	0°	4°	2°	2°
In-Out:	0,25mm	0,25mm	0,25mm	0,65mm	0,50mm	0,50mm	0,65mm	0,25mm	0,25mm	0,25mm
	15	14	13	12	11	21	22	23	24	25
Maxilar										
Mandibular										
	45	44	43	42	41	31	32	33	34	35
Longitud M-D	3 mm	3 mm	2,9 mm	2,7 mm	2,7 mm	2,7 mm	2,7 mm	2,9 mm	3 mm	3 mm
Torque:	-22°	-17°	-11°	0°	0°	0°	0°	-11°	-17°	-22°
Tip:	0°	0°	5°	0°	0°	0°	0°	5°	0°	0°
Rotación:	4°	4°	2°	0°	0°	0°	0°	2°	4°	4°
In-Out:	0,15mm	0,15mm	0,20mm	0,45mm	0,45mm	0,45mm	0,45mm	0,20mm	0,15mm	0,15mm

Prescripción MBT

SLOT .018" x .028" / .022" x .028"

Kit c/hook 3, 4, 5: 20 piezas

Longitud M-D	3 mm	3 mm	3 mm	2,7 mm	2,9 mm	2,9 mm	2,7 mm	3 mm	3 mm	3 mm
Torque:	-7°	-7°	-7°	10°	17°	17°	10°	-7°	-7°	-7°
Tip:	0°	0°	8°	8°	4°	4°	8°	8°	0°	0°
Rotación:	2°	2°	4°	0°	0°	0°	0°	4°	2°	2°
In-Out:	0,25mm	0,25mm	0,25mm	0,65mm	0,50mm	0,50mm	0,65mm	0,25mm	0,25mm	0,25mm
	15	14	13	12	11	21	22	23	24	25
Maxilar										
Mandibular										
	45	44	43	42	41	31	32	33	34	35
Longitud M-D	3 mm	3 mm	2,9 mm	2,7 mm	2,7 mm	2,7 mm	2,7 mm	2,9 mm	3 mm	3 mm
Torque:	-17°	-12°	-6°	-6°	-6°	-6°	-6°	-6°	-12°	-17°
Tip:	2°	2°	3°	0°	0°	0°	0°	3°	2°	2°
Rotación:	4°	4°	2°	0°	0°	0°	0°	2°	4°	4°
In-Out:	0,15mm	0,15mm	0,20mm	0,45mm	0,45mm	0,45mm	0,45mm	0,20mm	0,15mm	0,15mm



Prescripción DAMON* STANDARD

SLOT .022" x .028"

Kit c/hook 3, 4, 5: 20 piezas

Longitud M-D	3 mm	3 mm	3 mm	2,7 mm	2,9 mm	2,9 mm	2,7 mm	3 mm	3 mm	3 mm
Torque:	-11°	-11°	7°	6°	15°	15°	6°	7°	-11°	-11°
Tip:	2°	2°	5°	9°	5°	5°	9°	5°	2°	2°
Rotación:	2°	2°	4°	0°	0°	0°	0°	4°	2°	2°
In-Out:	0,25mm	0,25mm	0,25mm	0,65mm	0,50mm	0,50mm	0,65mm	0,25mm	0,25mm	0,25mm
	15	14	13	12	11	21	22	23	24	25
Maxilar										
Mandibular										
	45	44	43	42	41	31	32	33	34	35
Longitud M-D	3 mm	3 mm	2,9 mm	2,7 mm	2,7 mm	2,7 mm	2,7 mm	2,9 mm	3 mm	3 mm
Torque:	-17°	-12°	7°	-3°	-3°	-3°	-3°	7°	-12°	-17°
Tip:	4°	4°	5°	4°	2°	2°	4°	5°	4°	4°
Rotación:	4°	4°	2°	0°	0°	0°	0°	2°	4°	4°
In-Out:	0,15mm	0,15mm	0,20mm	0,45mm	0,45mm	0,45mm	0,45mm	0,20mm	0,15mm	0,15mm

Prescripción DAMON* LOW TORQUE

SLOT .022" x .028"

Kit c/hook 3, 4, 5: 20 piezas

Longitud M-D	3 mm	3 mm	3 mm	2,7 mm	2,9 mm	2,9 mm	2,7 mm	3 mm	3 mm	3 mm
Torque:	-11°	-11°	-9°	-5°	2°	2°	-5°	-9°	-11°	-11°
Tip:	2°	2°	5°	9°	5°	5°	9°	5°	2°	2°
Rotación:	2°	2°	4°	0°	0°	0°	0°	4°	2°	2°
In-Out:	0,25mm	0,25mm	0,25mm	0,65mm	0,50mm	0,50mm	0,65mm	0,25mm	0,25mm	0,25mm
	15	14	13	12	11	21	22	23	24	25
Maxilar										
Mandibular										
	45	44	43	42	41	31	32	33	34	35
Longitud M-D	3 mm	3 mm	2,9 mm	2,7 mm	2,7 mm	2,7 mm	2,7 mm	2,9 mm	3 mm	3 mm
Torque:	-17°	-12°	0°	-11°	-11°	-11°	-11°	0°	-12°	-17°
Tip:	4°	4°	5°	4°	2°	2°	4°	5°	4°	4°
Rotación:	4°	4°	2°	0°	0°	0°	0°	2°	4°	4°
In-Out:	0,15mm	0,15mm	0,20mm	0,45mm	0,45mm	0,45mm	0,45mm	0,20mm	0,15mm	0,15mm

Prescripción DAMON* HIGH TORQUE

SLOT .022" x .028"

Kit c/hook 3, 4, 5: 20 piezas

Longitud M-D	3 mm	3 mm	3 mm	2,7 mm	2,9 mm	2,9 mm	2,7 mm	3 mm	3 mm	3 mm
Torque:	-11°	-11°	11°	13°	22°	22°	13°	11°	-11°	-11°
Tip:	2°	2°	5°	9°	5°	5°	9°	5°	2°	2°
Rotación:	2°	2°	4°	0°	0°	0°	0°	4°	2°	2°
In-Out:	0,25mm	0,25mm	0,25mm	0,65mm	0,50mm	0,50mm	0,65mm	0,25mm	0,25mm	0,25mm
	15	14	13	12	11	21	22	23	24	25
Maxilar										
Mandibular										
	45	44	43	42	41	31	32	33	34	35
Longitud M-D	3 mm	3 mm	2,9 mm	2,7 mm	2,7 mm	2,7 mm	2,7 mm	2,9 mm	3 mm	3 mm
Torque:	-17°	-5°	13°	-3°	-3°	-3°	-3°	13°	-5°	-17°
Tip:	4°	4°	5°	4°	2°	2°	4°	5°	4°	4°
Rotación:	4°	4°	2°	0°	0°	0°	0°	2°	4°	4°
In-Out:	0,15mm	0,15mm	0,20mm	0,45mm	0,45mm	0,45mm	0,45mm	0,20mm	0,15mm	0,15mm

Prescripción ROTH

SLOT .018" x .028" / .022" x .028"

Kit c/hook 3, 4, 5: 20 piezas

Longitud M-D	3 mm	3 mm	3 mm	2,7 mm	2,9 mm	2,9 mm	2,7 mm	3 mm	3 mm	3 mm
Torque:	-7°	-7°	0°	8°	12°	12°	8°	0°	-7°	-7°
Tip:	0°	0°	11°	9°	5°	5°	9°	11°	0°	0°
Rotación:	2°	2°	4°	0°	0°	0°	0°	4°	2°	2°
In-Out:	0,25mm	0,25mm	0,25mm	0,65mm	0,50mm	0,50mm	0,65mm	0,25mm	0,25mm	0,25mm
	15	14	13	12	11	21	22	23	24	25
Maxilar										
Mandibular										
	45	44	43	42	41	31	32	33	34	35
Longitud M-D	3 mm	3 mm	2,9 mm	2,7 mm	2,7 mm	2,7 mm	2,7 mm	2,9 mm	3 mm	3 mm
Torque:	-22°	-17°	-11°	0°	0°	0°	0°	-11°	-17°	-22°
Tip:	0°	0°	5°	0°	0°	0°	0°	5°	0°	0°
Rotación:	4°	4°	2°	0°	0°	0°	0°	2°	4°	4°
In-Out:	0,15mm	0,15mm	0,20mm	0,45mm	0,45mm	0,45mm	0,45mm	0,20mm	0,15mm	0,15mm

Prescripción MBT

SLOT .018" x .028" / .022" x .028"

Kit c/hook 3, 4, 5: 20 piezas

Longitud M-D	3 mm	3 mm	3 mm	2,7 mm	2,9 mm	2,9 mm	2,7 mm	3 mm	3 mm	3 mm
Torque:	-7°	-7°	-7°	10°	17°	17°	10°	-7°	-7°	-7°
Tip:	0°	0°	8°	8°	4°	4°	8°	8°	0°	0°
Rotación:	2°	2°	4°	0°	0°	0°	0°	4°	2°	2°
In-Out:	0,25mm	0,25mm	0,25mm	0,65mm	0,50mm	0,50mm	0,65mm	0,25mm	0,25mm	0,25mm
	15	14	13	12	11	21	22	23	24	25
Maxilar										
Mandibular										
	45	44	43	42	41	31	32	33	34	35
Longitud M-D	3 mm	3 mm	2,9 mm	2,7 mm	2,7 mm	2,7 mm	2,7 mm	2,9 mm	3 mm	3 mm
Torque:	-17°	-12°	-6°	-6°	-6°	-6°	-6°	-6°	-12°	-17°
Tip:	2°	2°	3°	0°	0°	0°	0°	3°	2°	2°
Rotación:	4°	4°	2°	0°	0°	0°	0°	2°	4°	4°
In-Out:	0,15mm	0,15mm	0,20mm	0,45mm	0,45mm	0,45mm	0,45mm	0,20mm	0,15mm	0,15mm



INTERACTIVO

Prescripción DAMON* STD Bajo y Alto Torque

SLOT .022" x .028" Kit c/hook 3, 4, 5: 24 piezas 6x6

Longitud M-D	3,9 mm	3,9 mm
Torque:	-18°	-18°
Tip:	0°	0°
Rotación:	12°	12°
In-Out:	0,50mm	0,50mm

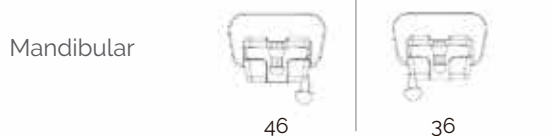

Longitud M-D	3,9 mm	3,9 mm
Torque:	-28°	-28°
Tip:	2°	2°
Rotación:	2°	2°
In-Out:	0,50mm	0,50mm

TUBO
AUTOLIGADO

Prescripción MBT-ROTH

SLOT .022" x .028" Kit c/hook 3, 4, 5: 24 piezas 6x6

Longitud M-D	3,9 mm	3,9 mm
Torque:	-10°	-10°
Tip:	0°	0°
Rotación:	8°	8°
In-Out:	0,50mm	0,50mm

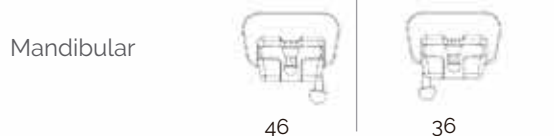
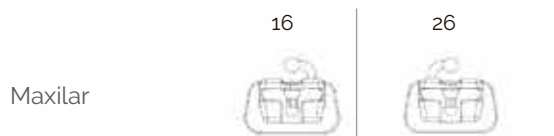

Longitud M-D	3,9 mm	3,9 mm
Torque:	-25°	-25°
Tip:	0°	0°
Rotación:	5°	5°
In-Out:	0,50mm	0,50mm

PROXIMAMENTE
Interactivo

Orthodont

CASA CENTRAL: Junin 987 1° piso, C.A.B.A.
Tel./Fax: (+54) (011) 4961-9260 • info@orthodont.com.ar

SUCURSAL: Montevideo 955 9° "A", C.A.B.A.
Tel./Fax: (+54) (011) 4816-2436 • sucursal@orthodont.com.ar

www.orthodont.com.ar

+54 9 11 6959-8903

/orthodont.argentina
 @OrthodontOK
 Orthodont Argentina
 @orthodont_argentina